

**Box Type Slide Unit. (360×130)****FSP-B.T.S.U.(360*130)****Order Code : #714****Technical Data**

Total Stroke	130 mm
Max Speed	3 m / min
Parallelity of Guideways	0.01 mm
Linear Guideway Type	Box Type Hardened Steel
Micro Switch Type	Balluff
Hydraulic Jack	F.S.P. Made
Working Pressure	Max 60 bar
Hydraulic Seals	Kastas
Weight	195 kg
Color	

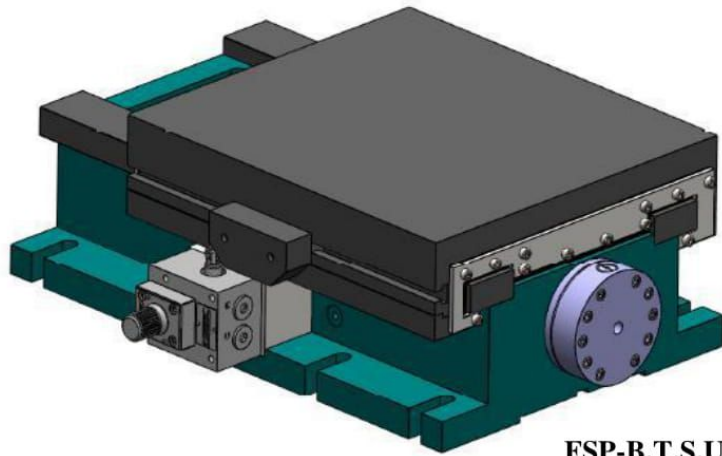

